

Spring series LFP Battery

RW-F16

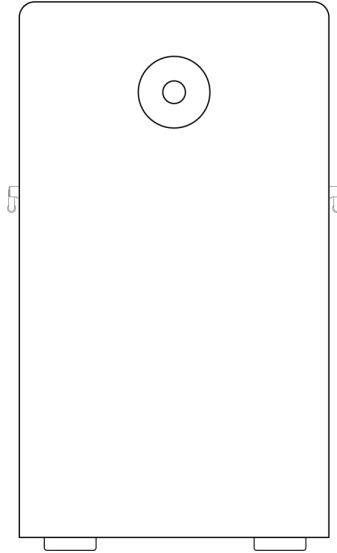

Issue: 02
Date: 20250108

How to Use This Manual

Read the manual and other related documents before performing any operation on the battery.

Documents must be stored carefully and be always available.

Contents may be periodically updated or revised due to product development. The information in this manual is subject to change without notice.

All Rights Reserved

No part of this document can be reproduced in any form or by any means without the formal permission of the manufacturer.

Trademarks and Permissions

Trademarks used in this manual are owned by the manufacturer. All other trademarks or registered trademarks mentioned in this manual are owned by their respective owners.

Software Licenses

- * It is prohibited to use data contained in firmware or software developed by the manufacturer , in part or in full, for commercial purposes by any means.
- * It is prohibited to perform reverse engineering, cracking, or any other operations that compromise the original program design of the software developed by the manufacturer.

Disclaimer

The manufacturer shall not be liable for personal injury, property loss, product damage and subsequent losses under the following circumstances:

- * Damages caused by force majeure, including earthquake, flood, volcanic eruption, mudslide,, lightning, fire, war, military conflict, typhoon, hurricane, and so on.
- * Failure to comply with the provisions of this manual.
- * The installation, operation and storage environment does not meet the relevant international, national or regional standards;
- * Incorrect use of this product.
- * Unauthorized or unqualified personnel repair the product, disassembly the rack and perform other operations.
- * Use of unapproved spare parts.
- * Unauthorized modifications or technical changes to the product or software.
- * Incorrect shipment by yourself or the third party commissioned by you.
- * Unsatisfactory materials and tools from you own that do not meet the relevant international, national or regional standards.
- * Damage caused by yourself or the third party's negligence, intent, gross negligence, or improper operation.

Contents

1 Safety Instructions.....	3
1.1 Terms and Symbols.....	3
1.2 Safety Rules.....	5
2 Product Description.....	6
2.1 Product Features.....	6
2.2 Application Scenarios.....	6
2.3 Product Overview.....	7
3 Preparation for Installation.....	10
3.1 Unpacking List.....	10
3.2 Required Tools.....	12
3.3 Safety Gear.....	12
4 Installation Instructions.....	14
4.1 Installation Personnel.....	14
4.2 Selection of Installation Sites.....	16
4.3 Installing the Battery.....	17
4.3.1 Wall-mounted.....	17
4.3.2 Floor-mounted.....	19
5. Electrical Connection.....	20
5.1 Wiring.....	20
5.2 Parallel Mode 1.....	21
5.3 Parallel Mode 2.....	22
5.4 Grounding.....	23
6 Power on/off the Product.....	23
7 Inspection, Cleaning and Maintenance.....	23
7.1 General Information.....	23
7.2 Inspection.....	24
7.3 Cleaning.....	24
8 Storage.....	25
9 Troubleshooting.....	26
10 Technical Specifications.....	28
11 Environmental Disposal.....	29
12 Transportation Requirements.....	30













1 Safety Instructions



Warning!

Read and follow carefully all safety warnings and all instructions . Failure to do so may result in electrical shock, fire, serious injury, or death. Save these instructions for future reference.

1.1 Terms and Symbols

Terms /Symbols	Description
 Danger	Indicates a hazard with a high level of risk which, if not avoided, will result in death or serious injury.
 Warning	Indicates a hazard with a medium level of risk which, if not avoided, will result in death or serious injury.
 Caution	Indicates a hazard with a low level of risk which, if not avoided, will result in minor or moderate injury.
 Notice	Indicates a potentially hazardous situation which, if not avoided, could results in equipment damage, data loss, performance deterioration, or unanticipated results. NOTICE is used to address practices not related to personal injury.
 Note	Supplements the important information in the main text. NOTE is used to address information not related to personal injury, equipment damage, and environment deterioration.
	Caution , risk of electric shock symbol indicates important safety instructions , which if not correctly followed , could result in electric shock.
	The DC input terminals of the inverter must not be grounded.
	Surface high temperature , Please do not touch the inverter case .
	CE mark of conformity
	Please read the instructions carefully before use .
	Indicate that this product is recyclable
	Do not place near open fire or incinerate. Do not use near heaters or hot temperature source.







	Attention! The risk of explosion.
	Li-ion battery
	Do not tread
	Do not run and chase
	Do not touch with your palm
	Symbol for the marking of electrical and electronics devices according to Directive 2002/96/ EC. Indicates that the device , accessories and the packaging must not be disposed as unsorted municipal waste and must be collected separately at the end of the usage . Please follow Local Ordinances or Regulations for disposal or contact an authorized representative of the manufacturer for information concerning the decommissioning of equipment.

Table-1 Definition

1.2 Safety Rules

- 1) After unpacking, please check product and packing list first, if product is damaged or lack of parts, please contact with the local retailer.
- 2) Before installation, be sure to cut off the grid power and make sure the battery is in the turned-off mode.
- 3) Wiring must be correct. Be careful to negative pole and positive of cable and terminals. Make sure no short circuit with the external device.
- 4) It is prohibited to connect the battery and AC power directly.
- 5) Please ensured the electrical parameters of battery system are compatible to related equipment.
- 6) Do not allow the terminals to contact exposed wire or metal.
- 7) Keep out of reach of children or animals.
- 8) Do not place batteries near fire, heater or high temperature sources. This will reduce the risk of explosion or possible injury.
- 9) Batteries can explode in the presence of a source of ignition, such as open flame. An exploded battery can propel debris and chemicals. If occurs, flush with water immediately.
- 10) Do not submerge the battery in water or expose it to moisture. Do not disassemble or alter the battery in any way.
- 11) If the battery system needs to be moved or repaired, the power must be cut off and the battery is completely shut down.
- 12) It is prohibited to connect the battery with different type of Battery.
- 13) It is prohibited to put the batteries into use with faulty or incompatible power conversion system (hereafter refers to "PCS").
- 14) It is prohibited to disassemble the battery.
- 15) In case of fire, only dry fire extinguishers can be used. Liquid fire extinguishers are forbidden.
- 16) Please do not open, repair, or disassemble the battery except qualified personnel. We do not undertake any consequences or related responsibility which be- cause of violation of safety operation or violating of design, production, and equipment safety standards.
- 17) Battery needs to be recharged within 48 hours after fully discharged.
- 18) Do not expose cable outside.
- 19) Do not expose battery to flammable or harsh chemicals or vapors.
- 20) Do not paint any part of Battery, include any internal or external components.
- 21) Do not connect battery with PV solar wiring directly.
- 22) Any foreign object is prohibited to insert into any part of battery.
- 23) Do not strike, drop, puncture or step on the battery. A damaged battery is subjected to explosion. Properly dispose of damaged battery immediately.
- 24) In case of electrolyte leakage, keep leaked electrolyte away from contact with eye or skin, If that occurs, wash immediately with clean water for at least 10 minutes, then seek immediate medical attention.

2 Product Description

2.1 Product Features

- 1) The lithium iron phosphate battery is one of new energy storage products, which can be used to support reliable power for various types of equipment and systems. The whole module is non-toxic, non-polluting, and environmentally friendly.
- 2) This product has built-in BMS battery management system, which can manage and monitor cells information including voltage, current and temperature. What' s more, BMS can balance cells charging and discharging to extend cycle life.
- 3) Cathode material is made from LiFePO_4 with safety performance and long cycle life.
- 4) Flexible configuration. Multiple batteries can be in parallel for expanding capacity and power.
- 5) Adopted self-cooling mode rapidly reduces system noise.
- 6) The module has less self-discharge, no memory effect, excellent performance of shallow charge and discharge.
- 7) Battery module communication address auto networking, easy maintenance, support remotely monitoring and upgrade the firmware.
- 8) High-power density: flat design, stack-mounted, saving installation space.
- 9) Restricted-current charging module can help improve battery life.

2.2 Application Scenarios

The following illustration shows basic application of this battery.

It also includes following devices to have a complete running system.

- Generator or Utility
- PV modules
- Low voltage Hybrid PCS (Charge & Discharge)

Consult with your system integrator for other possible system architectures depending on your requirements.

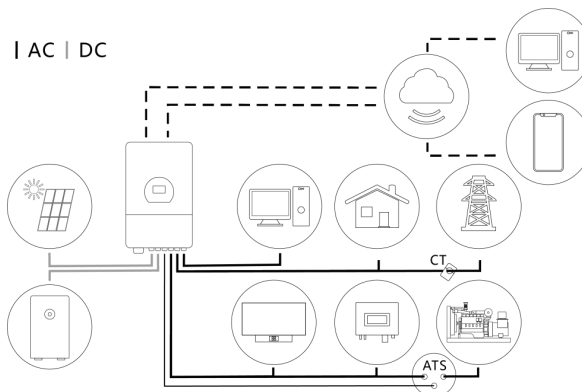

2.3 Product Overview

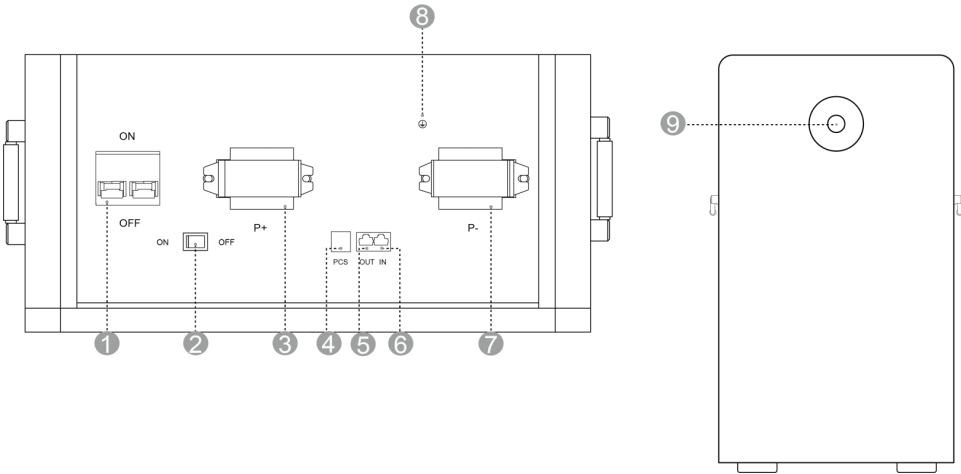

1. Service switch	6. IN port
2. BMS switch	7. P-
3. P+	8. Ground
4. PCS port	9. LCD screen
5. OUT port	

Table-2 Product Introduction

P+

Connect "P+" port of previous or next battery among multiple parallel batteries or BMS1 port of the PCS to deliver information between batteries and the PCS.

P-

Connect "P-" port of previous or next battery among multiple parallel batteries or BMS1 port of the PCS to deliver information between batteries and the PCS.

BMS switch

To turn ON/OFF the BMS of the battery.

Service switch

To power on /off the battery.

LCD screen

To indicate the state of the battery system

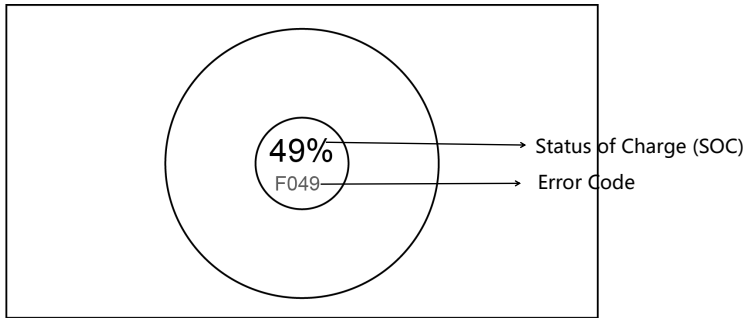

Condition	Performance
Normal	After initialized successfully, the LCD screen will be on for long time and shows the SOC in percentage. The screen stays on unless shutdown and dormancy
Abnormal	If the fault in the Table-4 occurs, the corresponding fault code will be displayed on the LCD screen. For details, refer to the Table-4.
Upgrade	When upgrading, the screen will be filled with the "upd" as well as the upgrade process in percentage .

Table-3 LCD Screen

Error Code	Connotation	Error Code	Connotation
01	Cell over voltage	29	EEPROM error
02	Cell under voltage	30	Internal communication fails
04	Ultimate_Protection	31	PCS communication fails
05	Charge over current	32	Master address repeat
06	Discharge over current	45	Cur Limit Mos Adhesion
07	Cell over temperature	46	Mos Adhesion Susp
08	Cell under temperature	47	Heat Mos adhesion
11	Cell voltage over difference	48	Heat error
12	Cell temperature over difference	49	Over connect temp
13	Mos over temperature	50	Pre charge fail
14	Heating film over temperature	51	Charge inverses
19	AFE-OCDL/OCD1/OCD2	52	Over terminal temp
25	AFE communication fails	53	Fuse blown
26	Cell voltage sampling fails	54	VOLT_OPEN_WIRE_FAIL
27	Temperature sampling fails	55	TEMP_OPEN_WIRE_FAIL
28	Mosfet short circuit		

Table-4 Error Code







Note: Your equipment is equipped with a buzzer, which will sound a alarm only when system is in over-temperature or over-voltage.

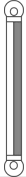

3 Preparation for Installation

After unpacking, check that packing contents are intact and complete, and free from any damage. If any item listed in the Unpacking List is missing or damaged, contact your vendor.

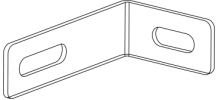
3.1 Unpacking List

		
Battery pack*1	PCS communication line*1	Ground wire*1

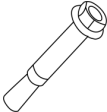
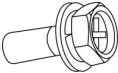
		
Fixed support*2	Battery positive line*1	Battery negative line*1



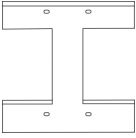
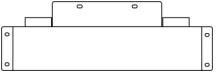
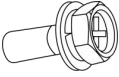

		
Expansion bolt*4 (M6*100)	Bolt*10 (M6)	User manual*1

		
<p>Hanging plate*1</p>	<p>Backplane*2</p>	<p>Bolt*2 (M4)</p>

<p>Dust-proof cover*1</p>

3.2 Required Tools

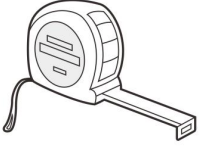
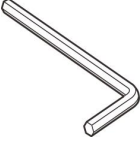
These tools are required to install the battery.

		
Hammer	Drill	Tape measure
		
Hex wrench	Phillips screwdriver	Marker



Note:

Use properly insulated tools to prevent accident tale electric shock or short circuits. If insulated tools are not available, cover the entire exposed metal surfaces of the available tools, except their tips, with electrical tape.

3.2 Safety Gear

It is recommended to wear the following safety gear when dealing with the battery pack.

		
Insulated gloves	Safety shoes	Safety goggles

4 Installation Instructions

4.1 Installation Personnel

Lithium battery is designed for outdoor use. But please avoid direct sunlight, rain exposure, snow laying up during installation and operation.

Make sure that the installation location meets the following conditions:

The installation area shall avoid of direct sunlight.

The floor and walls are completely water proof.

The wall is flat and level.

There are no flammable or explosive materials.

Ensure that the equipment is installed in a clean, dry and well ventilated area with proper temperature, humidity and altitude range. Check for more data in the "Technical Specifications" section.

There is minimal dust and dirt in the area.

Do not place the equipment near heat sources or fire sources, such as smoke, candies, heaters, or other heating devices. Overheat may damage the equipment or cause a fire.

The distance from air outlet of PCS is more than 0.5 meters.

Do not place at a children or pet touchable area.

There are no mandatory ventilation requirements for battery module, but please avoid of installation in confined area. Do not cover or wrap the battery case or cabinet.

Caution!

Cleaning. Before installing and powering up the system, dust and iron filings must be removed to keep the environment clean. The system cannot be installed in desert areas without a shell to protect against sand.

Caution!

Temperature. If the ambient temperature is not within the operating range, the battery pack stops operating to protect itself. Frequent exposure to harsh temperatures may deteriorate the performance and life of the battery pack.

Caution!

Fire extinguisher system. For safety, it is best to have a fire extinguisher system. The fire protection system needs to be checked regularly to keep it in normal condition. For use and maintenance requirements, follow local fire equipment guidelines.

 **Caution!**

Moving heavy objects. Be careful to prevent injury when moving heavy objects. Select an suitable way to moving heavy objects according to product weight. Refer to the table-5.

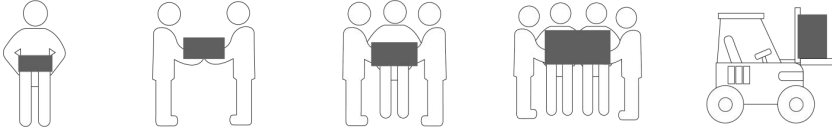

Weight	Method	Recommendation
<18 kg (40lbs)	Manual handling	1 person
18~32 kg (40~70lbs)	Manual handling	2 persons
32~55 kg (40~70lbs)	Manual handling	3 persons
55~68 kg (121~150lbs)	Manual handling	4 persons
> 68 kg (150lbs)	Moving device	Forklift

Table-5 Moving heavy objects

4.2 Selection of Installation Sites

⚠ Caution!

Batteries should be installed in a clean flat place with no direct sunlight, away from water and fire sources, and at a suitable temperature. The installation location is recommended to meet the size requirements of the figure below: $(0 \leq N \leq 29)$

NOTE: This requirement only applies to floor-mounted installation.

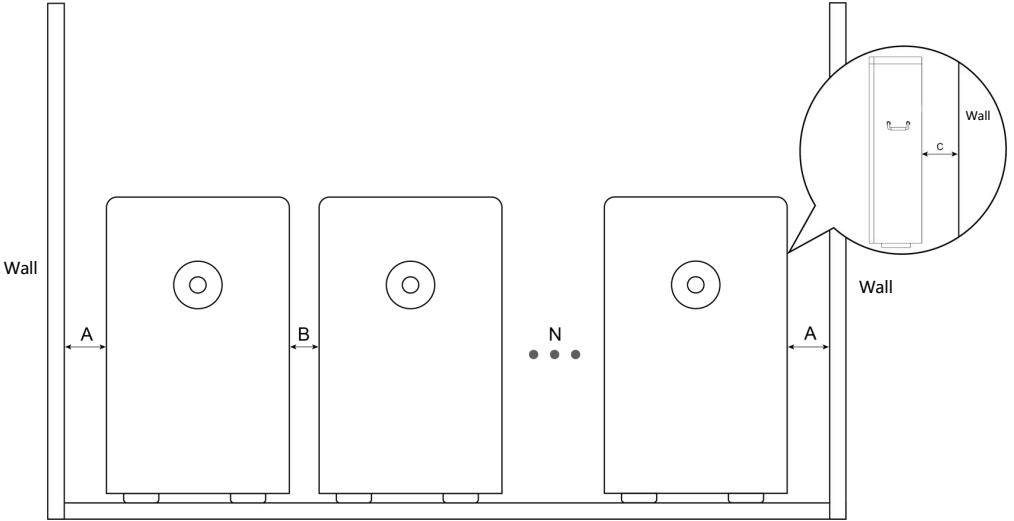

Item	Distance (mm)
A	200
B	400
C	0~40

Table-6 Clearance

4.3 Installing the Battery

4.3.1 Wall-mounted

- 1) Choose appropriate locations on the wall for drilling holes. Make sure to keep the bottom of the battery away from the ground when the entire installation is finished .
- 2) Drill 4 holes on the wall,with a diameter of 10mm and depth of 100~110mm.
- 3) Fix the hanging plate onto the wall with 4 expansion bolts (M6*100).

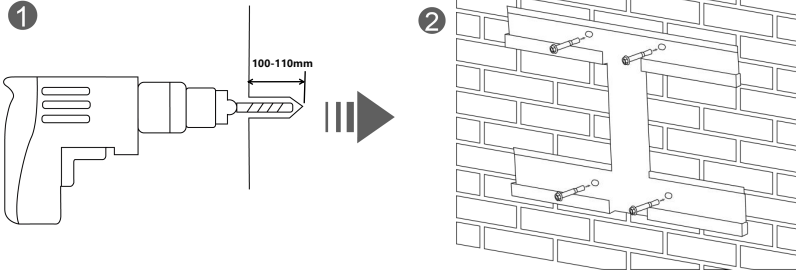

- 4)Use 10 screws of M6 to attach the backplane to the back of the battery.Tighten them.

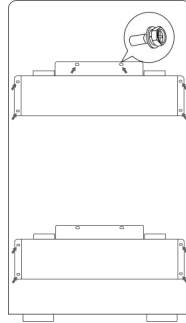

- 5) Carry the battery and hook it onto the hanging plate. Ensure that the upper and lower hooks of the backplane are accurately buckled on the hanging plate.

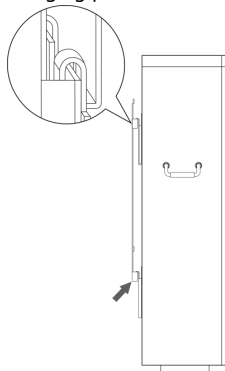

6) After wire connection has been finished, install the dust-proof cover with 2 screws of M4.

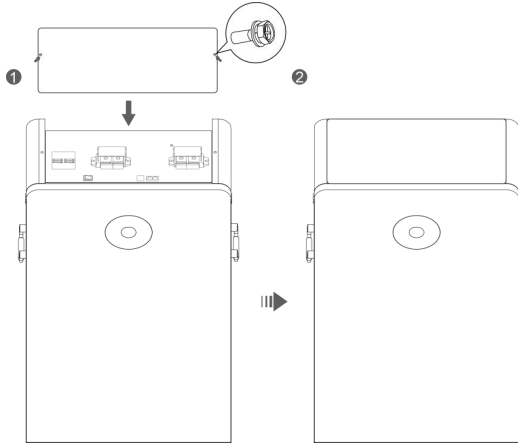

4.3.2 Floor-mounted

1) Use 2 screws of M6 to secure two fixed supports to the left and right side of the battery.

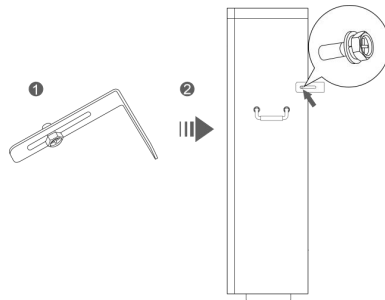

2) Make the back side of the battery close to the wall, and then mark locations of two assembly holes. Drill two holes and secure the battery to the wall in the same way as mentioned above in 4.3.1.

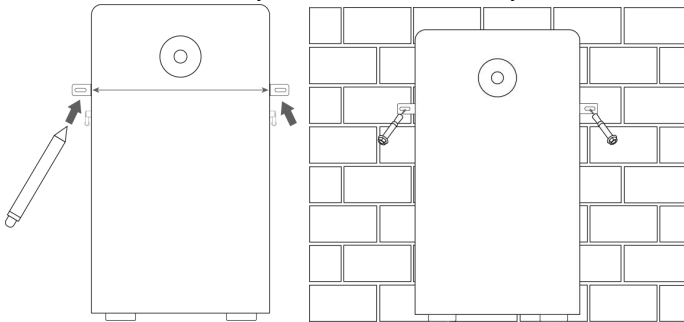

3) Adjust the left and right screws to the appropriate position to ensure that the battery is perpendicular to the ground.

4) After wire connection is finished, install the dust-proof cover with 2 screws of M4.

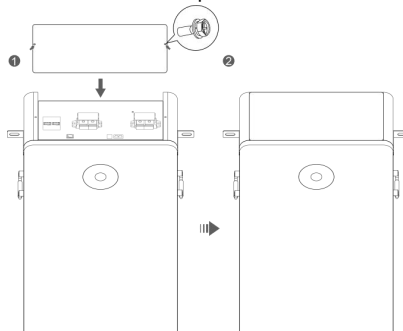

5. Electrical Connection

5.1 Wiring



Note!

- It is noted to distinguish the positive and negative ends of cables.
- Be careful to avoid misuse of lines used for communication between PCS and battery, battery and battery.
- Try to avoid cross-connection

When batteries need to be used together in parallel, you can select different parallel modes to meet your demands.

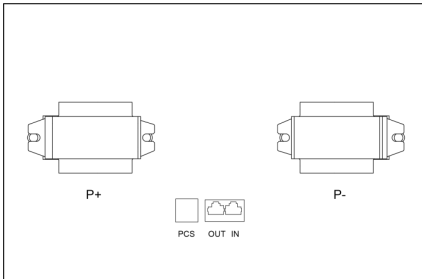

Definition of IN port pin		Definition of OUT port pin		Definition of PCS port pin	
No.	IN port pin	No.	OUT port pin	No.	PCS port pin
1	CANL	1	CANL	1	485-B
2	CANH	2	CANH	2	485-A
3	DI+	3	DO+	3	--
4	DI-	4	DO-	4	CANH
5	DI-	5	DO-	5	CANL
6	DI+	6	DO+	6	--
7	CANH	7	CANH	7	485-A
8	CANL	8	CANL	8	485-B

1. Attach the battery to the PCS by connecting the communication line into the "PCS" port, battery positive line into the "P+ " port and battery negative line into the "P- " port.
2. Attach one battery to another one by connecting the communication line from "OUT" port of previous battery to the "IN" port of the next battery, battery positive line into he "P+ " port and battery negative line into the "P- " port.

5.2 Parallel Mode 1 (the power of the PCS $\leq 8\text{kW}$)

Caution!

It should be noted that the maximum current of single battery system is 160A (the power of the PCS can not exceed 8 kW). Exceeding 160A will cause heating of the connectors and cable, and in severe cases, it will cause a fire accident.

If the power exceeds 8kW, the connection mode must be **Parallel Mode 2!**

Schematic diagram of connection of single battery system:

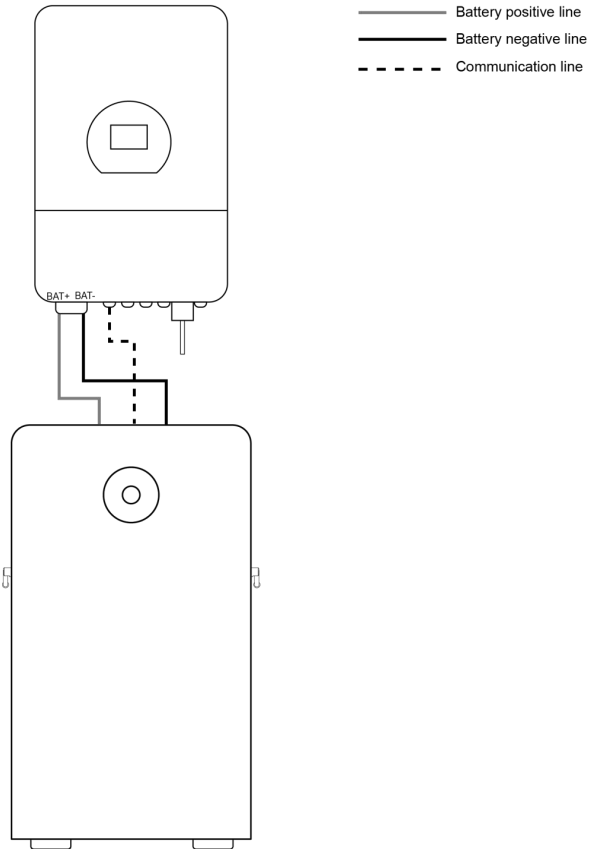

5.3 Parallel Mode 2 (the power of the PCS > 8kW)

Schematic diagram of connection of multiple batteries system:

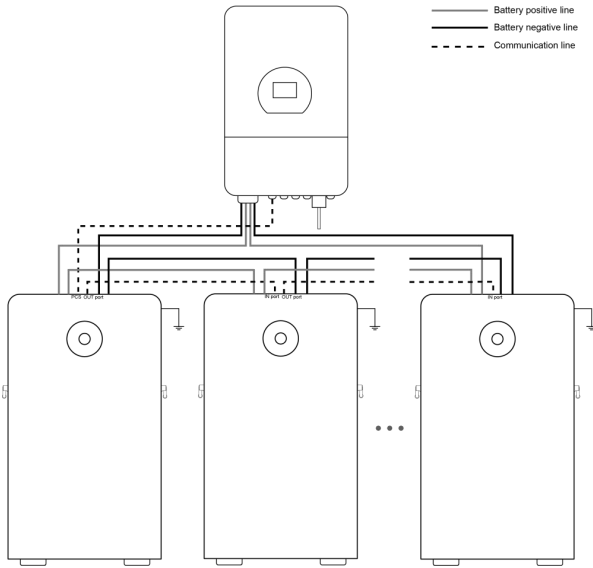

Or

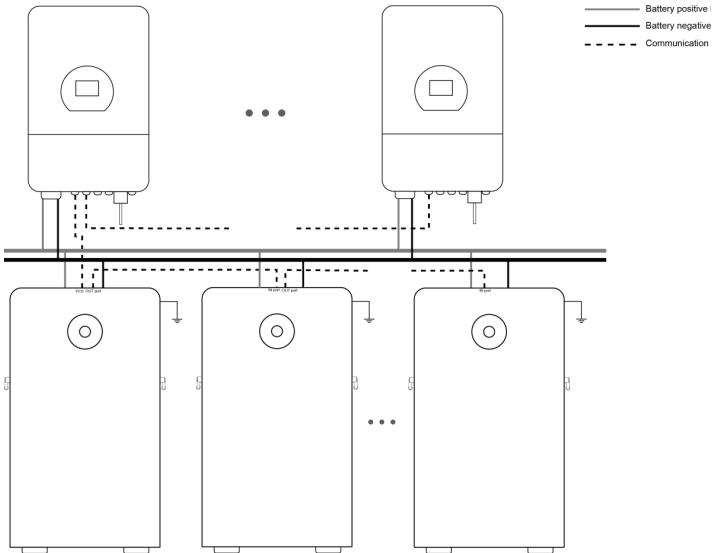

5.4 Grounding

Your battery system must be well grounded. Proceed as follows:

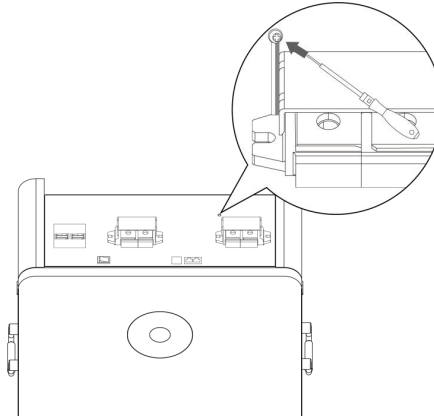

6 Power on/off the Product

Before operating the product, ensure that:

- All cables are wired correctly and firmly.
- All fasteners including bolts and screws are tightened firmly.
- No bystanders or animals enter into the working area.
- Keep foreign objects , especially metal, away from the battery .

1. Turn the service switch to the "ON" position.
2. Turn on the BMS switch. Once the LCD screen lights up, you can use the battery system normally.
3. After you finish your work, please switch off the BMS switch ,and then the service switch.

7 Inspection, Cleaning and Maintenance

7.1 General Information

- The battery product is not fully charged. It is recommended that the installation be completed within 3 months after arrival;
- During the maintenance process, do not re-install the battery in the battery product. Otherwise, the performance of the battery will be reduced;
- It is forbidden to dismantle any battery in the battery product, and it is forbidden to dis- sect the battery;
- After the battery product is over-discharged, it is recommended to charge the battery within 48 hours. The battery product can also be charged in parallel. After the battery product is connected in parallel, the

charger only needs to connect the output port of any product battery.

- Never attempt to open or dismantle the battery! The inside of the battery does not contain serviceable parts.
- Disconnect the Li-Ion battery from all loads and charging devices before performing cleaning and maintenance activities.
- Place the enclosed protective caps over the terminals before cleaning and maintenance activities to avoid the risk of contacting the terminals.
- All the battery terminals must be disconnected for maintenance.
- Please contact the supplier within 24 hours if there is something abnormal.
- Do not use cleaning solvents to clean battery.

7.2 Inspection

- Inspect for loose and/or damaged wiring and contacts, cracks, deformations, leakage, or damage of any other kind. If damage to the battery is found, it must be replaced. Do not attempt to charge or use a damaged battery. Do not touch the liquid from a ruptured battery.
- Regularly check the battery's state of charge. Lithium Iron Phosphate batteries will slowly self-discharge when not in use or whilst in storage.
- Consider replacing the battery with a new one if you note either of the following conditions:
 - The battery run time drops below 70% of the original run time.
 - The battery charge time increases significantly.

7.3 Cleaning

If necessary, clean the Li-Ion battery with a soft, dry cloth. Never use liquids, solvents, or abrasives to clean the Li-Ion battery.

7.4 Maintenance

The Li-Ion battery is maintenance-free. Charge the battery to approximately > 80% of its capacity at least once every year to preserve the battery capacity.

8 Storage

- The battery product should be stored in a dry, cool, and cool environment;
- If the battery is stored for long time, it is required to charge them every six months, and the SOC should be no less than 50%.
- Generally, the maximum storage period at room temperature is 6 months. When the battery is stored over 6 months, it is recommended to check the battery voltage. If the voltage is higher than 51.2V, it can continue to store the battery. In addition, it is needed to check the voltage at least once a month until the voltage is lower than 51.2V. When the voltage of the battery is lower than 51.2V, it must be charged according to the charging strategy.
- The charging strategy is as follows: discharge the battery to the cutoff voltage with 0.2C(62.8A) current, and then charge with 0.2C(62.8A) current for about 3 hours. Keep the SOC of the battery at 40% ~ 60% when stored;
- When the battery product is stored, the source of ignition or high temperature should be avoided and it should be kept away from explosive and flammable areas.

9 Troubleshooting

To determine the status of the battery system, users must use additional battery status monitoring software to examine the protection mode. Refer to the installation manual about using the monitoring software. Once the user knows the protection mode, refer to the following sections for solutions.

Fault Type	Phenomenons	Possible Causes	Solutions
Information collection fails	<p>The cell voltage sampling circuit is faulty.</p> <p>The cell temperature sampling circuit is faulty</p>	<p>The welding point for cell voltage sampling is loose or disconnected.</p> <p>The voltage sampling terminal is disconnected.</p> <p>The cell temperature sensor has failed.</p>	Replace the collection line.
Electrochemical cell error	The voltage of the cell is low or unbalanced.	<p>Due to large self- discharge, the cell over discharges to below 2.0V after long term storage.</p> <p>The cell is damaged by external factors, and short circuits, pinpricks, or crushing occur.</p>	Replace the battery.
Over-voltage protection fails	<p>The cell voltage is greater than 3.65 V in charging state.</p> <p>The battery voltage is greater than 58.4 V.</p>	<p>The busbar input voltage exceeds the normal value.</p> <p>Cells are not consistent. The capacity of some cells deteriorates too fast or the internal resistance of some cells is too high.</p>	If the battery cannot be recovered due to protection against abnormality contact local engineers to rectify the fault.
Under voltage protection fails	<p>The battery voltage is less than 44.8V.</p> <p>The minimum cell voltage is less than 2.8V</p>	<p>The mains power failure has lasted for a long time.</p> <p>Cells are not consistent. The capacity of some cells deteriorates too fast or the internal resistance of some cells is too high.</p>	Same as above.
Charge or discharge high temperature protection fails	The maximum cell temperature is greater than 60°C	<p>The battery ambient temperature is too high.</p> <p>There are abnormal heat sources around</p>	Same as above.
Charge low temperature	The minimum cell temperature is less	The battery ambient temperature is too low.	Same as above.

protection fails	than 0°C		
Discharge low temperature protection fails	The minimum cell temperature is less than -20°C	The battery ambient temperature is too low.	Same as above.

Table 7: Troubleshooting

By checking the above data and sending the data to the service personnel of our company, the service personnel of our company will reply the corresponding solution after receiving the data.

10 Technical Specifications

Main Parameter		RW-F16
Battery Chemistry		LiFePO ₄
Built-in Circuit Breaker		125A 2P, 60Vdc
Capacity (Ah) ^[1]		314
Scalability		Max.32 pcs pack (Max.512kWh) in parallel
Nominal Voltage (V)		51.2
Operating Voltage(V)		44.8~57.6
Nominal Energy (kWh) ^[1]		16
Usable Energy (kWh@90% DoD)		14.4
Charge/Discharge Current (A) ^[2]	Max. Continuous	160/160
	Peak	300/300 (10 sec)
Other Parameter		
Recommend Depth of Discharge		90%
Dimension (W/H/D, mm)		480×830×235 (Without hanging board and base)
Weight Approximate		122kg
Master LCD indicator		LCD(SOC and working state)
IP Rating of enclosure		IP20
Working Temperature		Charge: 0°C ~ 55°C Discharge: -20°C ~ 55°C
Recommended Operating Temperature		15°C ~ 35°C
Storage Temperature		0°C ~ 35°C
Relative Humidity		95%
Altitude		≤2000m
Cycle Life		≥6000(25°C±2°C,0.5C/0.5C,90% DOD ,70%EOL)
Installation		Wall-Mounted, Floor-Mounted
Communication Port		CAN2.0, RS485
Energy Throughput		52.5MWH (25°C,0.5C/0.5C,70%EOL)
Certification		UN38.3, MSDS

[1] Test condition: 25°C ± 2°C, at beginning of life, 0.5C charge & 0.5C discharge, 100% DOD.

[2] The current is affected by temperature and SOC.

11 Environmental Disposal

Used batteries can not be disposed of as household waste. You are obliged to handle waste batteries, such as removal of privacy on product, and return them to designated or authorized recovery point according to applicable regulations and standards on waste battery disposal.

Attention:

1. Do not dispose of batteries and rechargeable batteries as domestic waste!
You are legally obliged to return used batteries and rechargeable batteries.
2. Waste batteries may contain pollutants that can damage the environment or your health if improperly stored or handled.
3. Batteries also contain iron, lithium and other important raw materials, which can be recycled.

For more information, please visit <http://www.deyeess.com>. Do not dispose of batteries as household waste!



Li-ion



12 Transportation Requirements

1. The battery products should be transported after packaging and during the transportation process. Severe vibration, impact, or extrusion should be prevented to prevent sun and rain. It can be transported using vehicles such as cars, trains, and ships.
2. Always check all applicable local, national, and international regulations before transporting a Lithium Iron Phosphate battery.
3. Transporting an end-of-life, damaged, or recalled battery may, in certain cases, be specially limited or prohibited.
4. The transport of the Li-Ion battery falls under hazard class UN3480, class 9. For transport over water, air and land, the battery falls within packaging group PI965 Section I. Use Class 9 Miscellaneous Dangerous Goods and UN Identification labels for transportation of lithium-ion batteries which are assigned Class 9. Refer to relevant transportation documents.



Class 9 Miscellaneous Dangerous Goods and UN Identification Label